

**VAPORIZZATORE GPL ELETTRICO**  
**LPG ELECTRIC VAPORIZER EExd**  
**VAPORISATEUR GPL ELECTRIQUE EExd**

**50 Kg/h 8Kw**  
**Tipo feed-out**

**ATEX**

**COPRIM - ITALY**

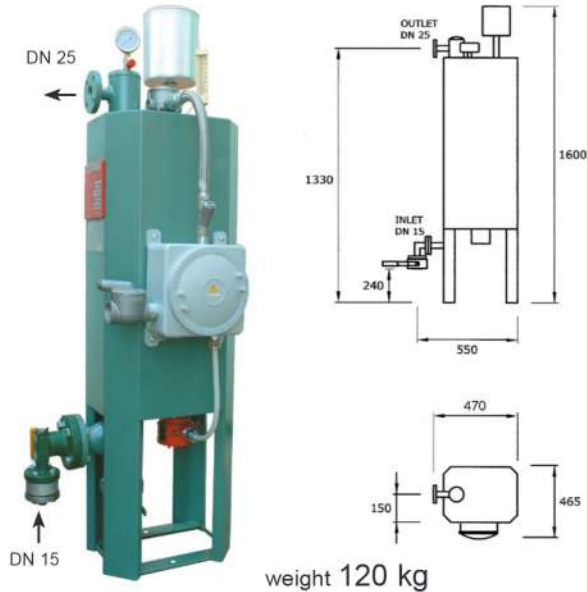

**Cod. 1.01.15**

box EExd con termostati  
**EExd box containing thermostat**  
 boîte EExd contenant thermostats

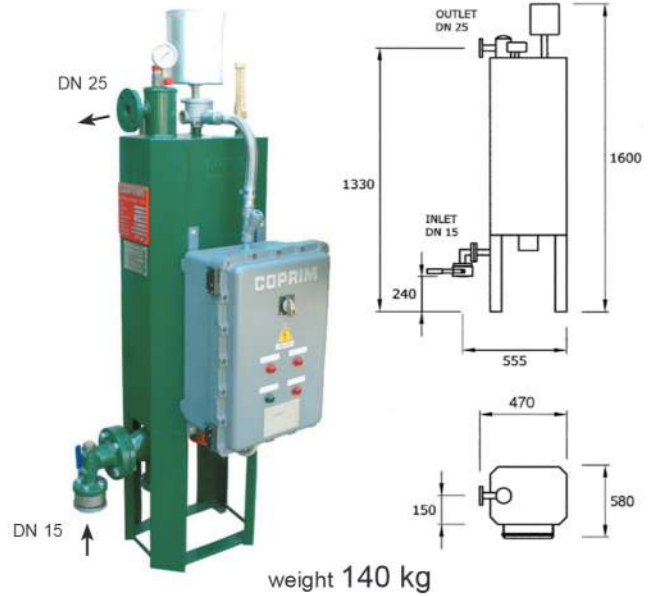

**Cod. 1.01.64**

con quadro di comando EExd  
**with EExd command board**  
 avec tableau de contrôle EExd



**temperatura progetto TS - 40 +120 °C**  
**design temperature - température de projet**

**pressione progetto PS 40 bar**  
**design pressure - pression de projet**

**SPECIFICA**

- Manometro Ø 60 25 bar
- Valvola di sicurezza 1/2" 18 bar
- Termometro -20 + 120 °C
- Filtro
- Valvola a sfera DN 15 PN 40
- Vaschetta espansione acqua
- n°1 resistenza elettr. EExd 8 kw
- Connessioni EExd

Contenuto acqua+glicole 45 lt.

**SPECIFICATIONS**

- Pressure gauge Ø 60 25 bar
- Safety valve 1/2" 18 bar
- Thermometer -20 + 120 °C
- Filter
- Ball valve DN 15 PN 40
- Water expansion pot
- n°1 electrical resistance 8 kw
- EExd connections

Water+glycole contained 45 lt

**SPÉCIFICATIONS**

- Manomètre Ø 60 25 bar
- Soupape de sécurité 1/2" 18 bar
- Thermomètre -20 + 120 °C
- Filtre
- Vanne sphérique DN 15 PN 40
- Vase d'expansion eau
- n°1 résistance électrique 8 kw
- Connexions EExd

Contenu eau+glycol 45 lt

**VAPORIZZATORE GPL ELETTRICO**  
**LPG ELECTRIC VAPORIZER EExd**  
**VAPORISATEUR GPL ELECTRIQUE EExd**

**100 Kg/h 16 Kw**  
**Tipo feed-out**

**ATEX**

**COPRIM - ITALY**

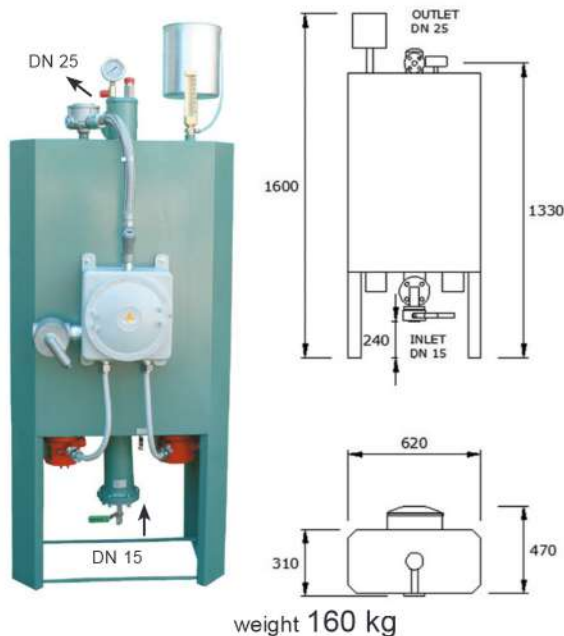

**Cod. 1.01.17**

box EExd con termostati  
 EExd box containing thermostat  
 boîte EExd contenant thermostats

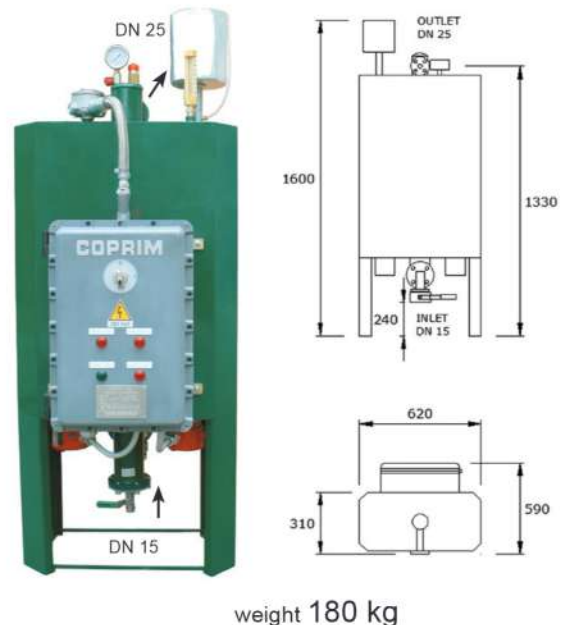

**Cod. 1.01.66**

con quadro di comando EExd  
 with EExd command board  
 avec tableau de contrôle EExd



**temperatura progetto TS - 40 +120 °C**  
 design temperature - température de projet

**pressione progetto PS 40 bar**  
 design pressure - pression de projet

**SPECIFICA**

- Manometro Ø 60 25 bar
- Valvola di sicurezza 1/2" 18 bar
- Termometro -20 + 120 °C
- Filtro
- Valvola a sfera DN 15 PN 40
- Vaschetta espansione acqua
- n°2 resistenze elettr. EExd 8 kw
- Connessioni EExd

Contenuto acqua+glicole 70 lt.

**SPECIFICATIONS**

- Pressure gauge Ø 60 25 bar
- Safety valve 1/2" 18 bar
- Thermometer -20 + 120 °C
- Filter
- Ball valve DN 15 PN 40
- Water expansion pot
- n°2 electrical resistances 8 kw
- EExd connections

Water+glycol contained 70 lt

**SPÉCIFICATIONS**

- Manomètre Ø 60 25 bar
- Soupape de sécurité 1/2" 18 bar
- Thermomètre -20 + 120 °C
- Filtre
- Vanne sphérique DN 15 PN 40
- Vase d'expansion eau
- n°2 résistances électriques 8kw
- Connexions EExd

contenu eau+glicol 70 lt

**VAPORIZZATORI GPL ELETTRICI**  
**LPG ELECTRIC VAPORIZERS EExd**  
**VAPORISATEURS GPL ELECTRIQUES EExd**

**150 - 200 - 300 Kg/h**  
**Tipo feed-out**  
**ATEX**  
**COPRIM - ITALY**

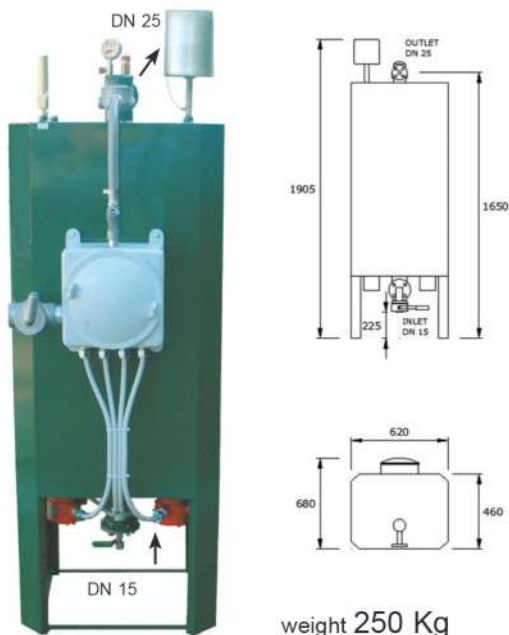

weight 250 Kg

Box EExd con termostati  
**EExd box containing thermostat**  
 boîte EExd contenant thermostats

Mod.	Cod.
<b>150 kg/h</b> 24 kw	<b>1.01.19</b>
<b>200 kg/h</b> 32 kw	<b>1.01.21</b>
<b>300 kg/h</b> 48 kw	<b>1.01.22</b>

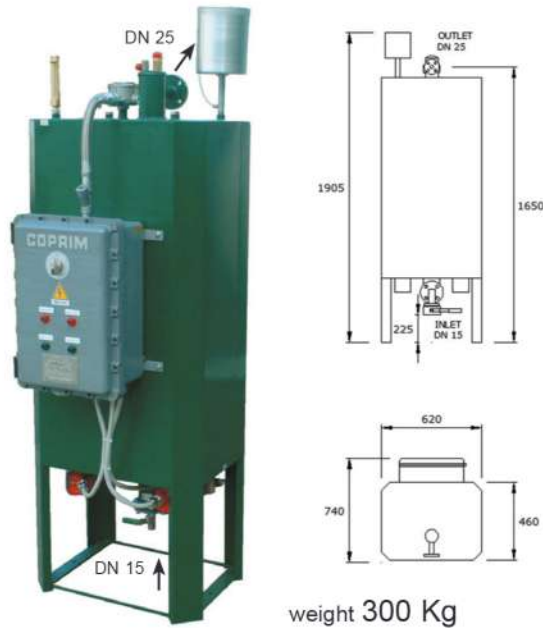

weight 300 Kg

con quadro di comando EExd  
**with EExd command board**  
 avec tableau de contrôle EExd

Mod.	Cod.
<b>150 kg/h</b> 24 kw	<b>1.01.68</b>
<b>200 kg/h</b> 32 kw	<b>1.01.70</b>
<b>300 kg/h</b> 48 kw	<b>1.01.72</b>



temperatura progetto **TS - 40 +120 °C**  
 design temperature - température de projet  
 pressione progetto **PS 40 bar**  
 design pressure - pression de projet

**SPECIFICA**

- Manometro Ø 60 25 bar
- Valvola di sicurezza 1/2" 18 bar
- Termometro -20 + 120 °C
- Filtro
- Valvola a sfera DN 15 PN 40
- Vaschetta espansione acqua
- Resistenze elettr. EExd 8 kw  
 (n°3 150 kg/h - n°4 200 kg/h - n°6 300 kg/h)
- Connessioni EExd

contenuto acqua + glicole 180 lt

**SPECIFICATIONS**

- Pressure gauge Ø 60 25 bar
- safety valve 1/2" 18 bar
- Thermometer -20 + 120 °C
- Filter
- Ball valve DN 15 PN 40
- Water expansion pot
- Electrical resistances 8 kw  
 (n°3 150 kg/h - n°4 200 kg/h - n°6 300 kg/h)
- EExd connections

water + glycole contained 180 lt

**SPÉCIFICATIONS**

- Manomètre Ø 60 25 bar
- Soupape de sécurité 1/2" 18 bar
- Thermomètre -20 + 120 °C
- Filtre
- Vanne sphérique DN 15 PN 40
- Vase d'expansion eau
- Résistances électriques 8 kw  
 (n°3 150 kg/h - n°4 200 kg/h - n°6 300 kg/h)
- Connexions EExd

contenu eau + glycol 180 lt

**VAPORIZZATORI GPL ELETTRICI DA  
LPG ELECTRIC VAPORIZERS EExd  
VAPORISATEURS GPL ELECTRIQUES EExd**

**400 - 500 kg/h**  
Tipo feed-out  
**ATEX**

**COPRIM - ITALY**

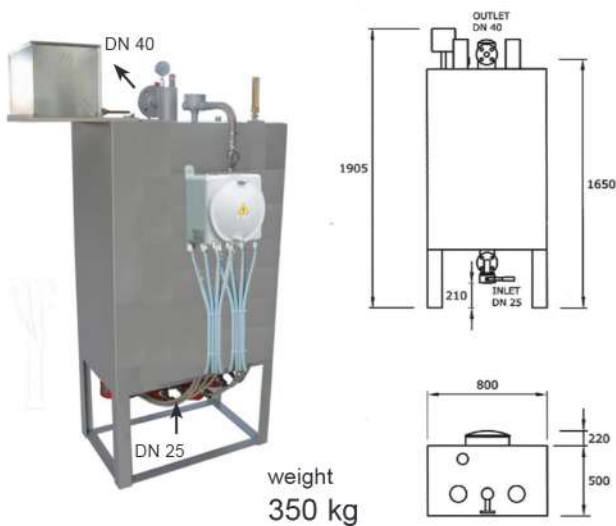

box EExd con termostati  
EExd box containing thermostat  
boîte EExd contenant thermostats

Mod.	Cod.
<b>400 kg/h</b> 64 kw	<b>1.01.25</b>
<b>500 kg/h</b> 80 kw	<b>1.01.30</b>

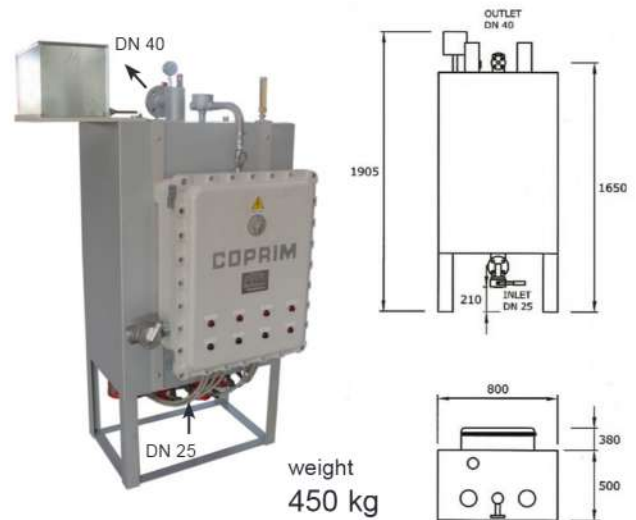

con quadro di comando EExd  
with EExd command board  
avec tableau de contrôle EExd

Mod.	Cod.
<b>400 kg/h</b> 64 kw	<b>1.01.75</b>
<b>500 kg/h</b> 80 kw	<b>1.01.80</b>



temperatura progetto **TS - 40 +120 °C**  
design temperature - température de projet

pressione progetto **PS 40 bar**  
design pressure - pression de projet

**SPECIFICA**

- Manometro Ø 60 25 bar
- Valvola di sicurezza 1/2" 18 bar
- Termometro -20 + 120 °C
- Filtro
- Valvola a sfera DN 25 PN 40
- Vaschetta espansione acqua
- 400-E**
- n°8 resistenze elettr. EExd 8 kw
- 500-E**
- n°10 resistenze elettr. EExd 8 kw
- Connessioni EExd
- Contenuto acqua+glicole 350 lt.

**SPECIFICATION**

- Pressure gauge Ø 60 25 bar
- Safety valve 1/2" 18 bar
- Thermometer -20 + 120 °C
- Filter
- Ball valve DN 25 PN 40
- Water expansion pot
- 400-E**
- n°8 resistances EExd 8 kw
- 500-E**
- n°10 resistances EExd 8 kw
- EExd connections
- Water+glycole contained 350 lt

**SPÉCIFICATIONS**

- Manomètre Ø 60 25 bar
- Soupape de sécurité 1/2" 18 bar
- Thermomètre -20 + 120 °C
- Filtre
- Vanne sphérique DN 25 PN 40
- Vase d'expansion eau
- 400-E**
- n°8 resistances électriques EExd 8 kw
- 500-E**
- n°10 resistances électriques EExd 8 kw
- Connexions EExd
- Contenu eau+glycol 350 lt

**VAPORIZZATORI GPL ELETTRICI Tipo feed-back**  
**LPG ELECTRIC VAPORIZERS EExd**  
**VAPORISATEURS GPL ELECTRIQUE EExd**

**ATEX**  
**COPRIM - ITALY**



Box EExd  
 con termostati  
**EExd box containing  
 thermostat**  
 boîte EExd contenant  
 thermostats



con quadro di comando  
 EExd  
**with EExd command board**  
 avec tableau de contrôle  
 EExd

VAP.	Cod.
25 Kg/h	1.02.25
50 kg/h	1.02.26
100 Kg/h	1.02.27
150 Kg/h	1.02.28
200 Kg/h	1.02.29
300 Kg/h	1.02.30
500 Kg/h	1.02.31

VAP.	Cod.
25 Kg/h	1.02.35
50 kg/h	1.02.36
100 Kg/h	1.02.37
150 Kg/h	1.02.38
200 Kg/h	1.02.39
300 Kg/h	1.02.40
500 Kg/h	1.02.41

quadro IP55  
 non compreso  
**command board  
 excluded**  
 tableau de bord  
 pas compris

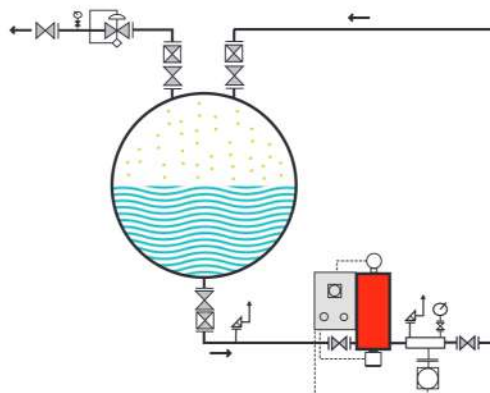
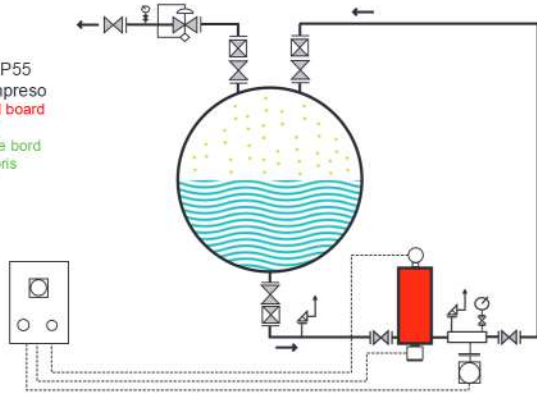

**CE INAIL 0100** **PED**  
**modulo H - H1** Pressure  
**Garanzia di Qualità Totale** Equipment  
 Directive

**temperatura progetto TS - 40 +120 °C**  
**design temperature - température de projet**

**pressione progetto PS 40 bar**  
**design pressure - pression de projet**

**SPECIFICA**

- Manometro Ø60 25 bar con contatti
- Valvola di sicurezza 1/2" 18 bar
- Termometro -20 + 120 °C
- Vaschetta espansione acqua
- Resistenze elettr. EExd 8 kw
- Pressostato
- contenuto acqua + glicole

**SPECIFICATIONS**

- Pressure gauge Ø 60 25 bar  
with contact
- safety valve 1/2" 18 bar
- Thermometer -20 + 120 °C
- Water expansion pot
- Electrical resistances 8 kw
- Pressure switch
- water + glycole contained

**SPÉCIFICATIONS**

- Manomètre Ø60 25 bar
- Soupape de sécurité 1/2" 18 bar
- Thermomètre -20 + 120 °C
- Vase d'expansion eau
- Résistances électriques 8 kw
- Pressostat
- contenu eau + glycol

**VAPORIZZATORI GPL ELETTRICI con termostati elettronici**

**LPG ELECTRIC VAPORIZER EExd with electronic thermostat**

**VAPORISATEUR GPL ELECTRIQUE EExd avec thermostats électroniques**

**COPRIM - ITALY**

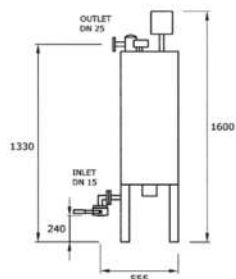

**50 kg/h 8 kw Cod. 1.01.641**

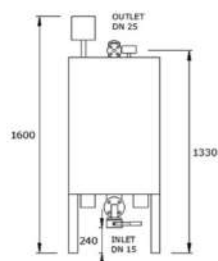
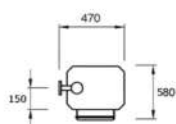

**100 kg/h 16 kw Cod. 1.01.661**

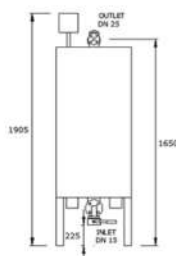
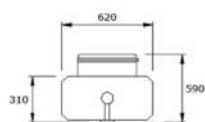

**150 kg/h 24 kw Cod. 1.01.681**

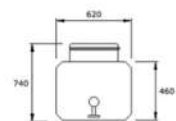

**200 kg/h 32 kw Cod. 1.01.701**

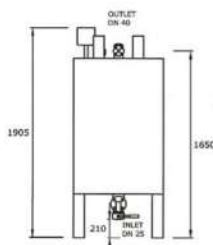

**300 kg/h 48 kw Cod. 1.01.721**

**400 kg/h 64 kw Cod. 1.01.751**

**500 kg/h 80 kw Cod. 1.01.801**

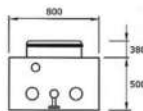

**Equipaggiati con termostati elettronici**

**Equipped with electronic thermostat**

**Équipés avec thermostats électroniques**



# QUADRI ELETTRICI COMANDO VAPORIZZATORI GPL

Command boards for LPG vaporizers

Tableau de bord pour vaporisateurs GPL

**COPRIM - ITALY**

**IP 55** (no EExd)

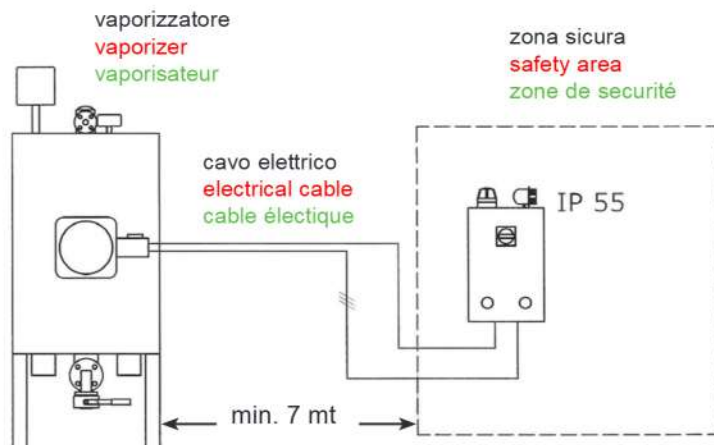

VAP	RES. EL	Cod.
25/E	4 Kw	1.06.10
50/E	8 Kw	1.06.20
100/E	16 Kw	1.06.30
150/E	24 Kw	1.06.40
200/E	32 Kw	1.06.50
300/E	48 Kw	1.06.60
400/E	64 Kw	1.06.65
500/E	80 Kw	1.06.70

## QUADRO COMANDO ELETTROVALVOLA

Electrovalve command board

Tableau de bord électrovanne

Da posizionare in zona sicura

To be placed in safety area

A' positionner en zone de sécurité

Cod. **1.06.05**



### COMPLETI DI:

- Interruttore generale con blocco porta
- Fusibili di protezione
- Teleruttore
- Trasformatore per circuito di comando
- Relay di comando
- Lampada di segnalazione marcia - arresto
- Allarme visivo
- Allarme acustico

### COMPLETE OF:

- Switch with door lock
- Safety fuses
- Contactors
- Transformer for control circuit
- Control relay
- Indicators light ON - OFF
- Visual alarm
- Acoustic alarm

### COMPLET DE:

- Interrupteur avec bloc porte
- Fusibles de protection
- Contacteurs
- Transformateur pour circuit de contrôle
- Relay de commande
- Lampes de communication
- Alarme visuelle
- Alarme acoustique